



SSC8035GS6B

P-Channel Enhancement Mode MOSFET

➤ Features

V_{DS}	V_{GS}	$R_{DS(ON)}$ Typ.	I_D
-30V	$\pm 12V$	58m Ω @-10V	-4A
		67m Ω @-4V5	
		86m Ω @-2V5	

➤ Description

This device is produced with high cell density DMOS trench technology, which is especially used to minimize on-state resistance. This device particularly suits low voltage applications such as portable equipment, power management and other battery powered circuits, and low in-line power dissipation are needed in a very small outline surface mount package.

➤ Applications

- TFT panel power switch
- Portable DVD, DPF
- High side DCDC converter
- High side driver for brushless DC motor

➤ Ordering Information

Device	Package	Shipping
SSC8035GS6B	SOT-23	3000/Reel

➤ Pin configuration

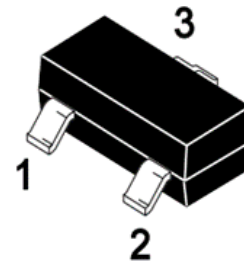

SOT-23

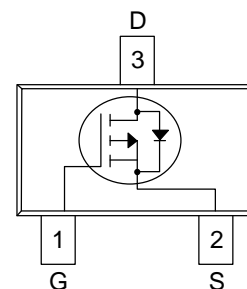

Pin Configuration (Top View)

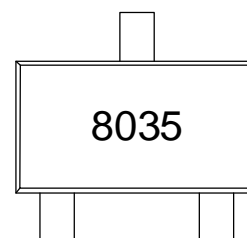

Marking



➤ **Absolute Maximum Ratings ($T_A=25^{\circ}\text{C}$ unless otherwise noted)**

Symbol	Parameter	Ratings	Unit
V_{DSS}	Drain-to-Source Voltage	-30	V
V_{GSS}	Gate-to-Source Voltage	± 12	V
I_D	Continuous Drain Current ^a	-4	A
I_{DM}	Pulsed Drain Current ^b	-16	A
P_D	Power Dissipation ^c	1.52	W
T_J	Operation junction temperature	-55~150	$^{\circ}\text{C}$
T_{STG}	Storage temperature range	-55~150	$^{\circ}\text{C}$

➤ **Thermal Resistance Ratings ($T_A=25^{\circ}\text{C}$ unless otherwise noted)**

Symbol	Parameter	Typical	Maximum	Unit
$R_{\theta JA}$	Junction-to-Ambient Thermal Resistance ^a	80	104	$^{\circ}\text{C}/\text{W}$

Note:

- The value of $R_{\theta JA}$ is measured with the device mounted on 1 in² FR-4 board with 2oz.copper, in a still air environment with $T_A=25^{\circ}\text{C}$. The value in any given application depends on the user is specific board design. The power dissipation is based on the $t \leq 10\text{s}$ thermal resistance rating.
- Repetitive rating, pulse width limited by junction temperature.
- The power dissipation P_D is based on $T_{J(MAX)}=150^{\circ}\text{C}$, using junction-to-case thermal resistance, and is more useful in setting the upper dissipation limit for cases where additional heat sinking is used.



➤ **Electrical Characteristics (T_A=25°C unless otherwise noted)**

Parameter	Symbol	Test Conditions	Min.	Typ.	Max.	Unit
Drain-Source Breakdown Voltage	V _{(BR)DSS}	V _{GS} = 0V, I _D = -250uA	-30			V
Gate Threshold Voltage	V _{GS(th)}	V _{DS} = V _{GS} , I _D = -250uA	-0.5	-0.75	-1.5	V
Drain-Source On-Resistance	R _{DS(on)}	V _{GS} = -10V, I _D = -4A		58	75	mΩ
		V _{GS} = -4.5V, I _D = -2A		67	85	
		V _{GS} = -2.5V, I _D = -1A		86	120	
Zero Gate Voltage Drain Current	I _{DSS}	V _{DS} = -30V, V _{GS} = 0V			-1	uA
Gate-Source Leak Current	I _{GSS}	V _{GS} = ±12V, V _{DS} = 0V			±100	nA
Transconductance	G _{FS}	V _{DS} = -5V, I _D = -3A		8		s
Forward Voltage	V _{SD}	V _{GS} = 0V, I _S = -1A		-0.8	-1.3	V
Input Capacitance	C _{ISS}	V _{DS} = -15V, V _{GS} = 0V, f = 1MHz		560		pF
Output Capacitance	C _{OSS}			62		
Reverse Transfer Capacitance	C _{RSS}			52		
Turn-on Delay Time	T _{D(ON)}	V _{GS} = -10V, V _{DS} = -15V, R _L = 4Ω, R _G = 3Ω		9.5		ns
Rise Time	T _r			8		
Turn-off Delay Time	T _{D(OFF)}			31		
Fall Time	T _f			23		
Total Gate Charge	Q _G	V _{GS} = -10V, V _{DS} = -15V, I _D = -4A		11		nC
Gate to Source Charge	Q _{GS}			2.4		
Gate to Drain Charge	Q _{GD}			2.8		



➤ **Typical Performance Characteristics (T_A=25°C unless otherwise noted)**

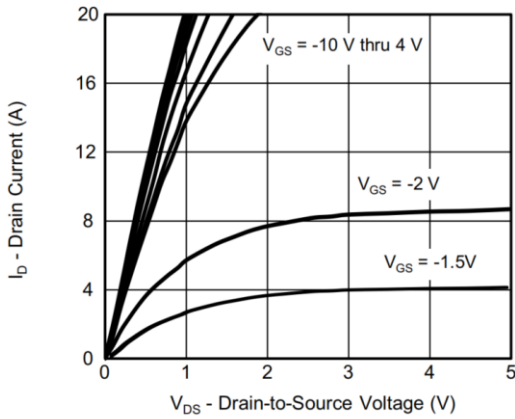

Output Characteristics

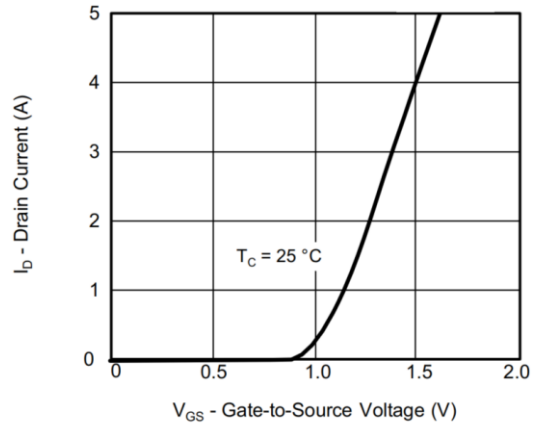

Transfer Characteristics

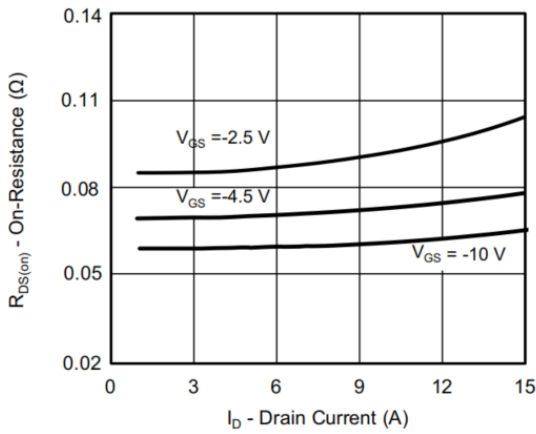

On-Resistance vs. Drain Current and Gate Voltage

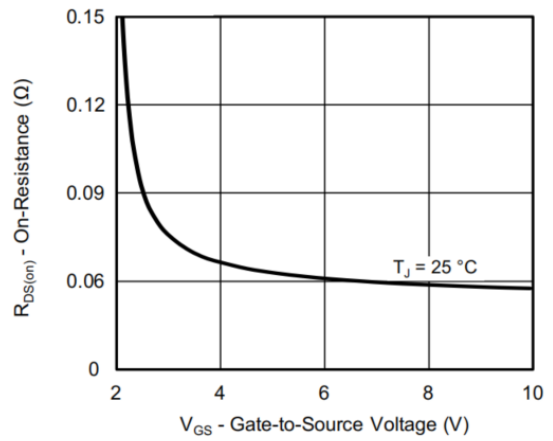

On-Resistance vs. Gate-to-Source Voltage

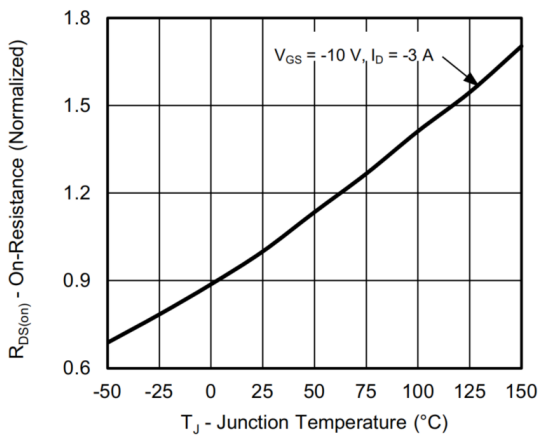

On-Resistance vs. Junction Temperature

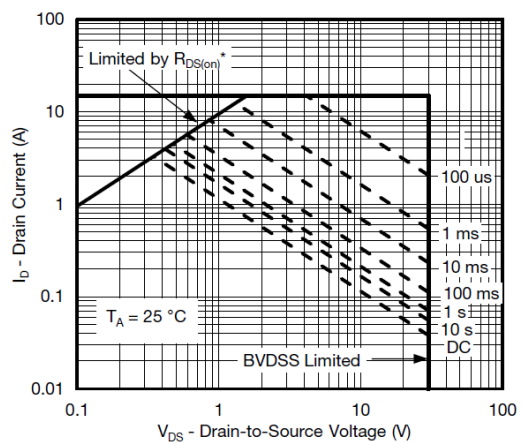

Safe Operating Area, Junction-to-Ambient



➤ Package Information

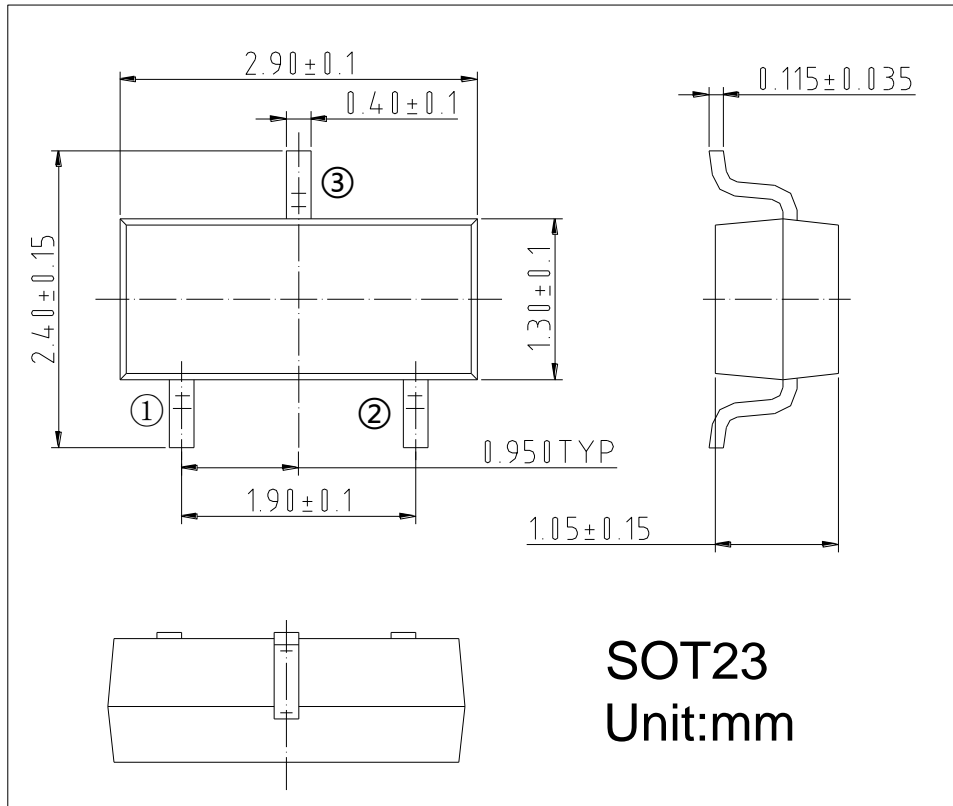

➤ Suggested Pad Layout

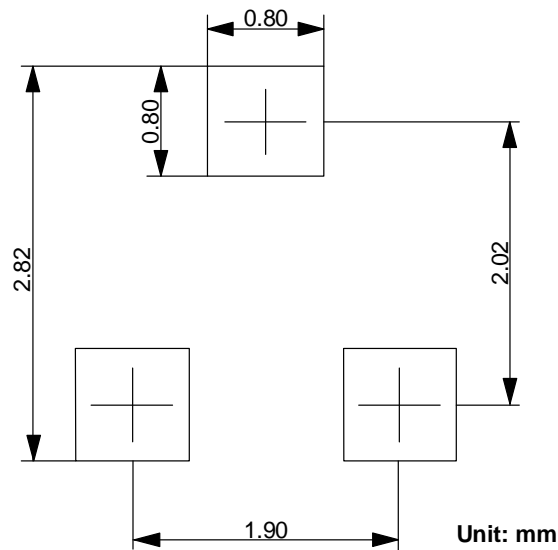



DISCLAIMER

SSCSEMI RESERVES THE RIGHT TO MAKE CHANGES WITHOUT FURTHER NOTICE TO ANY PRODUCTS HEREIN TO IMPROVE RELIABILITY, FUNCTION OR DESIGN. SSCSEMI DOES NOT ASSUME ANY LIABILITY ARISING OUT OF THE APPLICATION OR USE OF ANY PRODUCT OR CIRCUIT DESCRIBED HEREIN; NEITHER DOES IT CONVEY ANY LICIENCE UNDER ITS PATENT RIGHTS, NOR THE RIGHTS OF OTHERS.

THE GRAPHS PROVIDED IN THIS DOCUMENT ARE STATISTICAL SUMMARIES BASED ON A LIMITED NUMBER OF SAMPLES AND ARE PROVIDED FOR INFORMATIONAL PURPOSE ONLY. THE PERFORMANCE CHARACTERISTICS LISTED IN THEM ARE NOT TESTED OR GUARANTEED. IN SOME GRAPHS, THE DATA PRESENTED MAY BE OUTSIDE THE SPECIFIED OPERATING RANGE (E.G. OUTSIDE SPECIFIED POWER SUPPLY RANGE) AND THEREFORE OUTSIDE THE WARRANTED RANGE.

OUR PRODUCT SPECIFICATIONS ARE ONLY VALID IF OBTAINED THROUGH THE COMPANY'S OFFICIAL WEBSITE, CRM SYSTEM, OR OUR SALES PERSONNEL CHANNELS. IF CHANGES OR SPECIAL VERSIONS ARE INVOLVED, THEY MUST BE STAMPED WITH A QUALITY SEAL AND MARKED WITH A SPECIAL VERSION NUMBER TO BE VALID.